

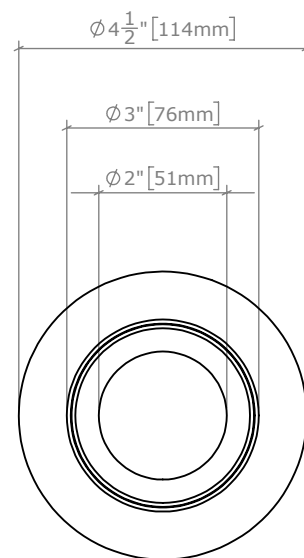

TUBO DIRECT - CEILING MOUNT - (DOWN LIGHT)
LGN-C716-LED-CHR
QTY:20

REVISIONS		
REV.	DESCRIPTION	DATE
0	ISSUED FOR APPROVAL	2021-04-06

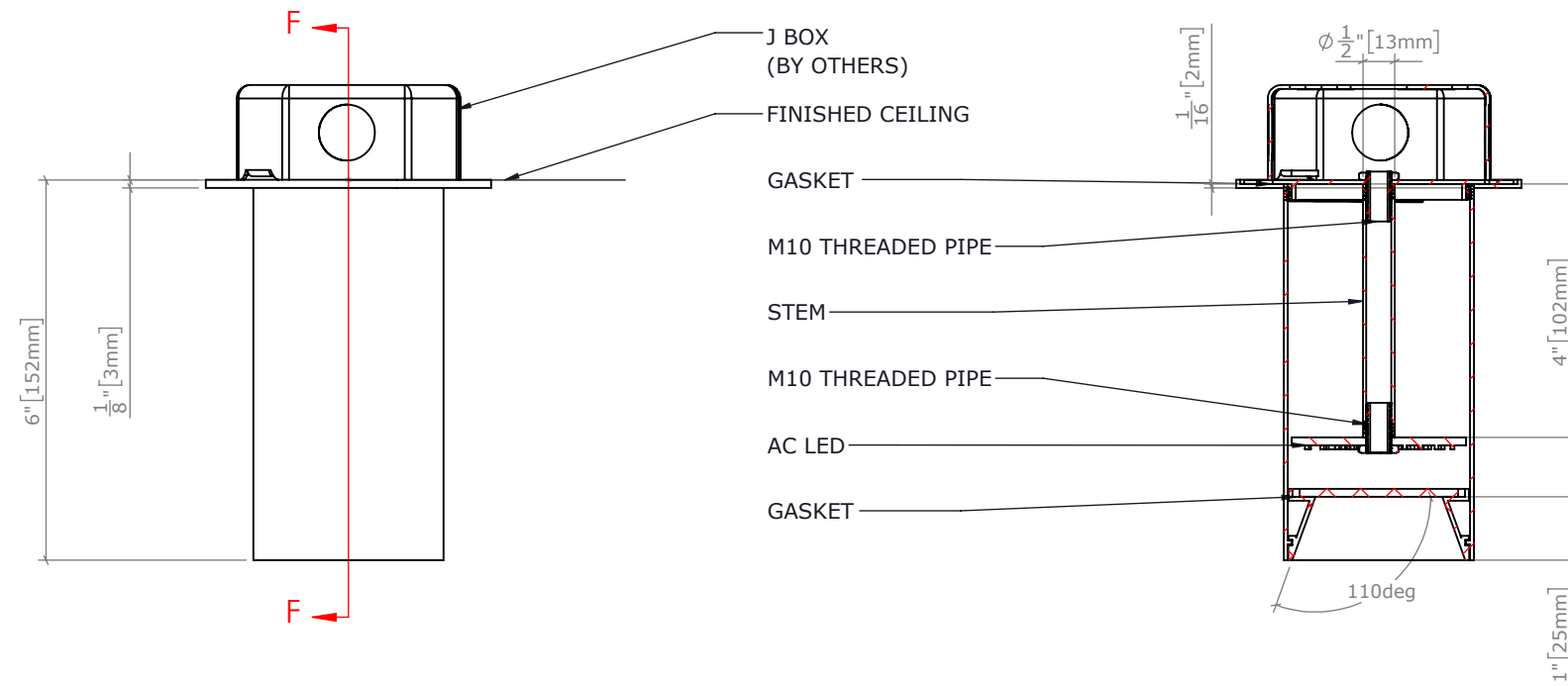

ALUMINUM BODY STRUCTURE
FINISH: POWDER COATED
(COLOUR - MATTE BLACK)

GLASS DIFFUSER
FINISH: CLEAR

DIFFUSER TRIM
FINISH: POWDER COATED
(COLOUR - MATTE BLACK)

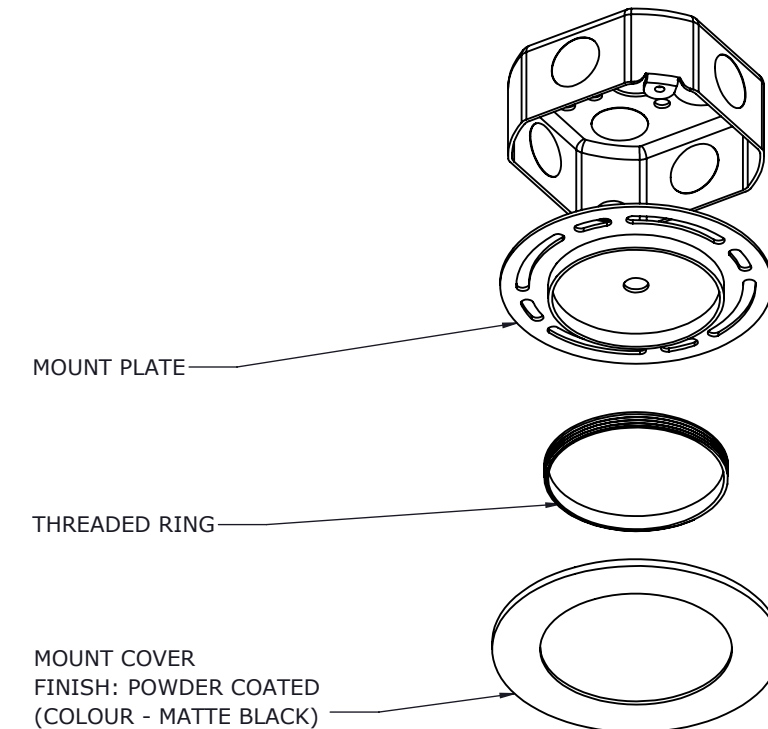
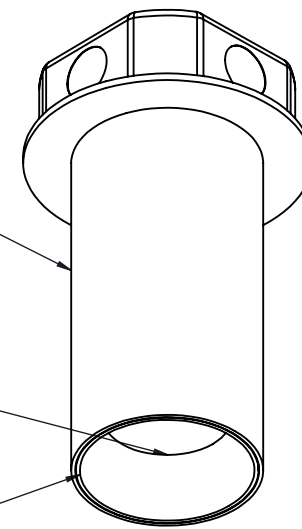

LAMPING:
AC LED BOARD 7W, 700LM, 4000K, CRI 90
TRIAC DIMMING

NOTES:
TRIAC DIMMING
FINISHES AVAILABLE IN BLACK, WHITE, CHROME
IP65 RATED

PROJECT: TUBO

LAMP: AC LED 7W, 700LM, 4000K, CRI 90

DWG:OC24238

SALES: FL

CERT.: ETL

BY: AA

MODEL: C716

WEIGHT: ±5LBS

DATE: 2021-04-06

VOLT:120V

SCALE: 1:3

TUBO DIRECT - CEILING MOUNT - (DOWN LIGHT)
LGN-C716-LED-CHR
QTY:20

REVISIONS		
REV.	DESCRIPTION	DATE
0	ISSUED FOR APPROVAL	2021-04-06

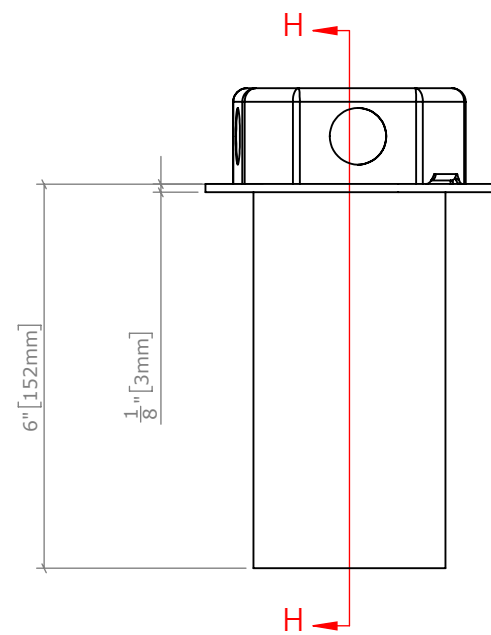

SECTION H-H
SCALE 1 : 3

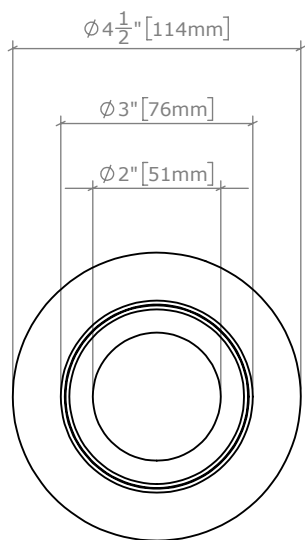
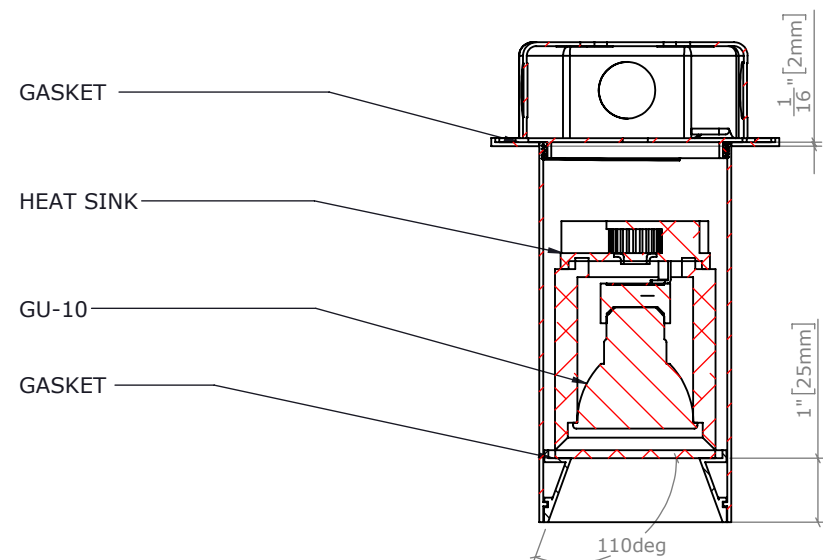

ALUMINUM BODY STRUCTURE
 FINISH: POWDER COATED
 (COLOUR - MATTE BLACK)

GLASS DIFFUSER
 FINISH: CLEAR

DIFFUSER TRIM
 FINISH: POWDER COATED
 (COLOUR - MATTE BLACK)

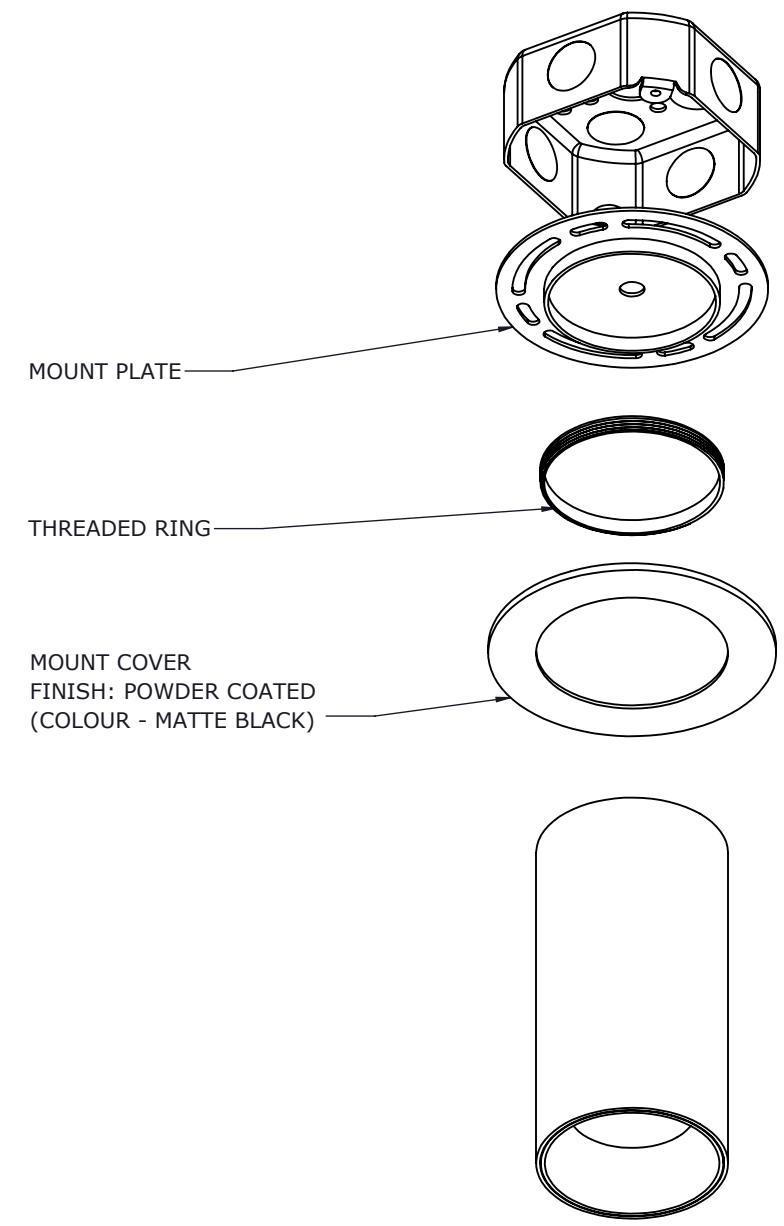
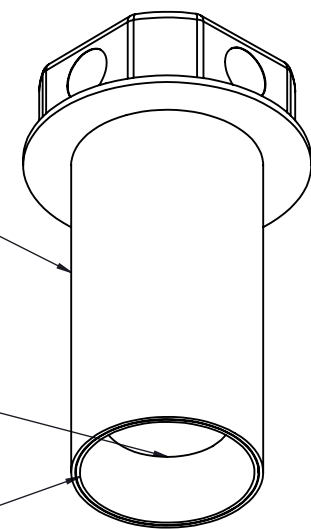

LAMPING: GU-10 BASE 50W
 SUGGEST: GU-10 BASE 50W, 500LM, 4000K, CRI90
 DIMMABLE BULB
 TRIAC DIMMING

PROJECT: TUBO	SALES: FL	MODEL: C716
LAMP: GU-10 BASE 50W	CERT.: ETL	WEIGHT: ±5LBS VOLT:120V
DWG:OC24238	BY: AA DATE: 2021-04-06	SCALE: 1:3

NOTES:
TRIAC DIMMING
FINISHES AVAILABLE IN BLACK, WHITE, CHROME
IP65 RATED

Presented drawings represent ideas and concepts, and may change in manufacturer and installation.
 All preparation for installation of fixture is to be provided by the end user.
 The description and measurements on this drawing are for information purposes only.